



ST RAPHAEL

RESORT & MARINA



LIMASSOL - CYPRUS

Resort Fact Sheet



#Radiatekindness



Luxury

5-star Resort

SCAN ME



HOTEL OVERVIEW

GENERAL INFORMATION

Our award winning, 5 - Star luxury St Raphael Resort & Marina in Limassol Cyprus, is situated on perhaps one of the best and largest Blue Flag accredited beaches on the outskirts of the lively cosmopolitan city of Limassol. An ideal family Resort promising you a comfortable and relaxing stay away from home.

All rooms have recently been fully renovated, with the latest amenities and facilities. Our Executive wing consists of 56 rooms, with separate children sleeping areas, suitable for families. Moreover, the hotel has 9 distinguished Suites, including 2 Presidential, 4 Admiral and the Founder's Suite that feature the epitome in comfort and luxury.

For our guests' culinary preferences, our Resort offers a variety of exclusive restaurants and bars as part of our guests' terms of stay (All-Inclusive, Half Board or Bed and Breakfast).

Our mission is to be an eco-friendly, sustainable five-star hotel proving that large resorts can still have a minimum carbon footprint while offering ultimate luxury that our customers are accustomed to.

We believe in being honest with our guests, while being kind to the planet. We take responsibility in our actions, and we look to our guests and team members to help us constantly evolve to find new and innovative ways to make the difference.

LOCATION

The resort is located right on a beautiful sandy, Blue Flag awarded beach and is built amidst beautifully landscape gardens.

- Various shops, bars and restaurants are within walking distance
- Limassol town centre is just 11km
- Larnaca International Airport: 55 km / 40 min
- Paphos International Airport: 70 km / 50 min
- Bus stop to the town centre & to both airports is just 50 metres from the Resort
- Taxi service 24/7

ADDRESS

502 Amathus Avenue, 4534 Pyrgos, Limassol, Cyprus
T: +357 25 834200 | F: +357 25 636394
E: info@straphael.com | W: www.straphael.com



OFFICIAL CLASSIFICATION

5-star Resort ★★★★★



ST RAPHAEL

RESORT & MARINA



LIMASSOL - CYPRUS

Rooms & Suites



#Radiatekindness



Rooms & Suites



BREAKDOWN OF ACCOMMODATION OF 272 ROOMS & SUITES

- 162 Sea View rooms
- 56 Executive spacious rooms with large veranda
- 31 Front Sea View & Marina view rooms
- 12 Family Inland View rooms - no balcony
- 4 Imperial Marina View rooms
- 4 Admiral Suites with Private Jacuzzi
- 1 Luxury Founder's Suite - Honeymoon
- 2 Luxury Presidential Suites



Family Inland View

- **Total area:** 35m²
- **Available rooms:** 12
- **Bed options:** King size bed, Bunk Beds
- **Maximum capacity:** 3 adults or 2 adults and 3 children

Description: Relax and keep the whole family together in our spacious 35m² Family Inland View rooms on the North side of the main hotel building. Able to accommodate a large family consisting of up to two adults and three children, our Family Inland View Rooms provide remarkable panoramic views of Limassol's iconic mountain range and North facing hotel gardens. Keeping your family needs in mind, Family rooms feature children's bunk beds, a spacious work area, and a seating area for families to regroup and curl up while watching Television during the hotter hours of the day. These rooms do not have balconies.

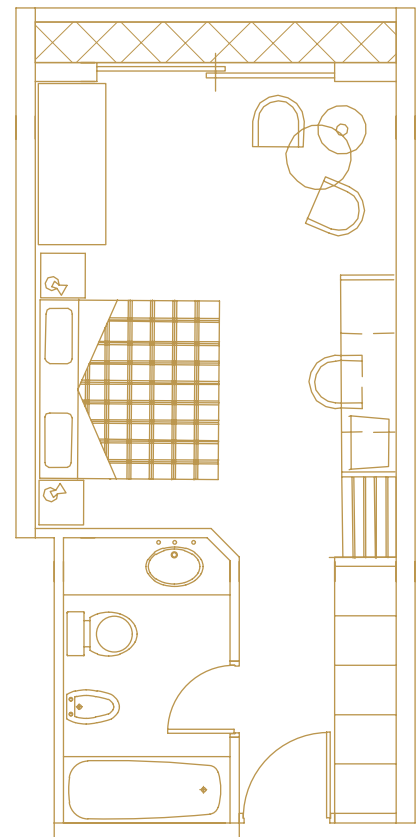

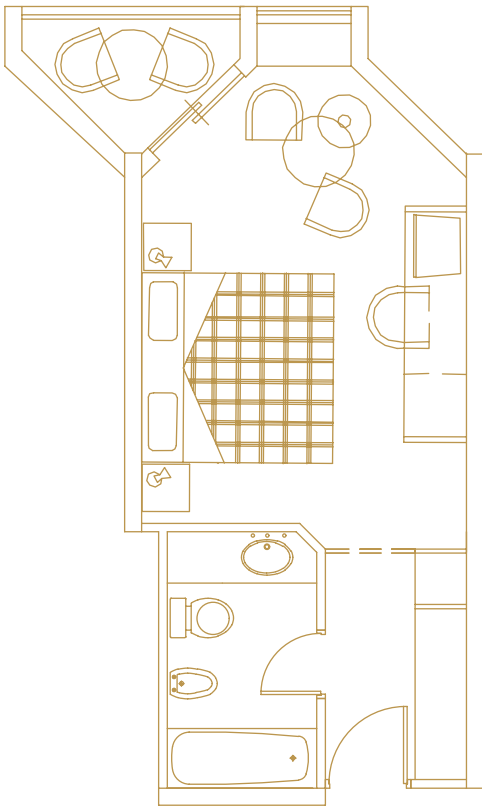

Sea View

- **Total area:** 27m²
- **Available rooms:** 162
- **Bed options:** Queen or twin singles
- **Balcony area:** 2.60 m²
- **Maximum capacity:** 3 adults or 2 adults and 1 child

Description: Enjoy the sea breeze right at the private balcony of your room and witness spectacular East or West sea views of Limassol Bay's crystal clear blue Mediterranean waters. These rooms feature double or twin beds in an elegant, stylish, and spacious interior, which make these rooms a popular and sought-after room category ideal for couples and young families.



Marina View

- **Total area:** 27m²
- **Available rooms:** 31
- **Bed options:** Queen or twin singles, Sofa Bed (Bunk Bed)
- **Balcony area:** 5m²
- **Maximum capacity:** 3 adults or 2 adults and 2 children

Description: Immerse yourself in the beauty of your surroundings with a stay in one of our unique and spacious Marina View rooms. Wake up to panoramic full-frontal views of the marina and our beautifully landscaped gardens, from your large balcony and marvel at the ever changing "wallpaper" of the picturesque scenery outdoors. This popular room type is a long-time favourite and is ideal for couples or small families looking for the perfect vacation. Our bright decor complements a spacious 27m² room featuring both queen and twin single beds.

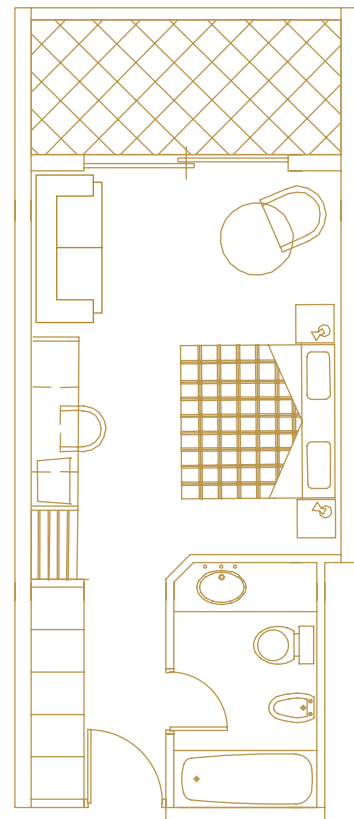

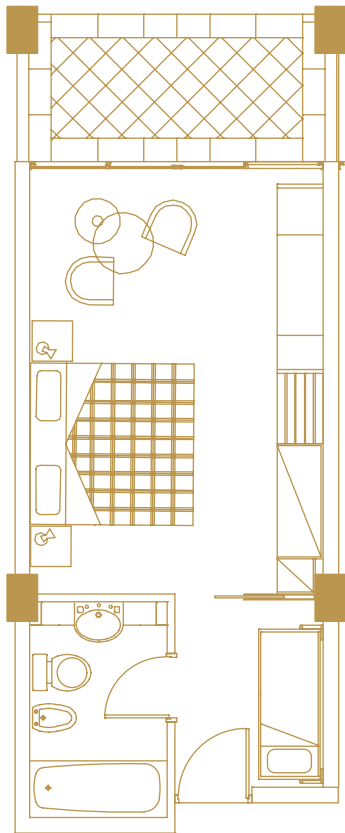

Executive Inland

- **Total area:** 37m²
- **Available rooms:** 21
- **Bed options:** King size bed, Bunk Beds
- **Balcony area:** 7.5 m²
- **Maximum capacity:** 2 adults or 2 adults & 2 children

Description: Enjoy the sea breeze right at the private balcony of your room and witness spectacular East or West sea views of Limassol Bay's crystal clear blue Mediterranean waters. These rooms feature double or twin beds in an elegant, stylish, and spacious interior, which make these rooms a popular and sought-after room category ideal for couples and young families.



Executive Marina View

- **Total area:** 37m²
- **Available rooms:** 35
- **Bed options:** King size bed, Bunk Beds
- **Balcony area:** 16.5m²
- **Maximum capacity:** 2 adults & 2 children

Description: If you feel like spending a little extra and want some additional space for yourselves and your family, our spacious and stylish Executive Marina View Rooms at 37m² in the Executive Wing, provide spectacular panoramic views of the Marina and the Hotel gardens. If you are still considering booking our Executive Marina View Room, be aware that aside from style and ample space, there is one more incredible feature that you should know about – the spectacular private terrace. Ideal for sunbathing and al fresco in room dining, the tiled terrace is equipped with two sunbeds and a beautifully laid out seating area that offers the best vantage point in the resort. Ideal for both business as well as leisure travellers with families, our Executive Marina View Rooms include all the necessities for an unforgettable stay.

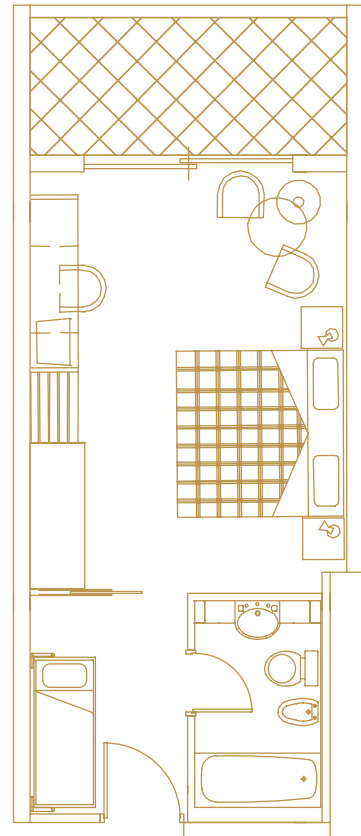

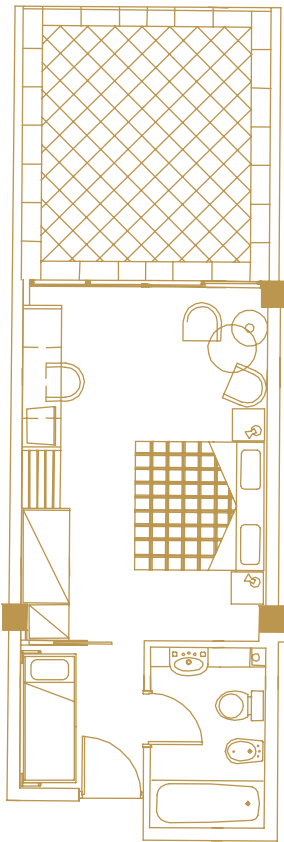

Executive Pool with Terrace

- **Total area:** 37m²
- **Available rooms:** 7
- **Bed options:** King size bed, Bunk Beds
- **Balcony area:** 16.5m²
- **Maximum capacity:** 2 adults & 2 children

Description: No need to go for a long walk back to your room after a dip in the pool - lay back in your own pool side private veranda and enjoy the breeze just a few steps away from your room and within sight of the sea, with our unique Executive Pool Level Rooms. Our well-appointed spacious pool level Executive Rooms (37m²) offer a perfect setting for families where children can splash around in the pool under their parent's supervision, as they lounge in their private veranda soaking in the sun. Identical to the Executive Marina View Room in terms of style and amenities this room category remains in high demand.



Two Bedroom Family Sea View

- **Total area:** 54 m²
- **Available rooms:** 22
- **Bed Options:** One queen & 2 twin singles beds
- **Balcony area:** Two balconies each 2.60m²
- **Maximum capacity:** 3 adults & 3 children (minimum capacity: 2 adults & 2 children)

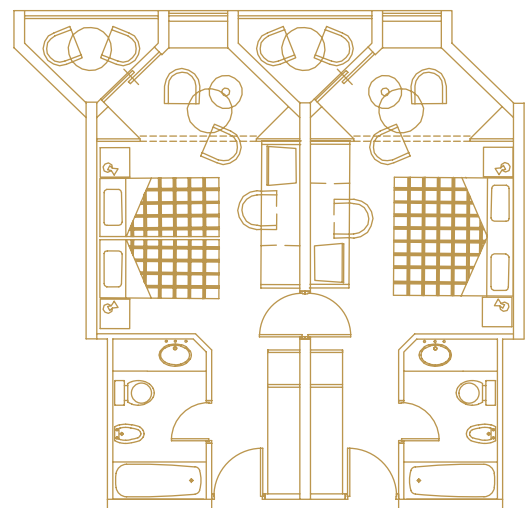

Description: The modern Two-Bedroom Sea View room (interconnecting rooms) is suitable for family or friends for an unforgettable holiday experience. With stunning endless views of the St Raphael Marina, the beach, and landscape gardens, these two bedrooms make it a comfortable home away from home combining functionality and elegance promising you a peaceful and relaxing stay. Comfort meets luxury - two light beach view bedrooms with ensuite bathrooms, a comfortable seating area and two private balconies separated by a door for privacy, these rooms are ideal for the perfect escape while staying at St Raphael Resort. With a queen-size bed in the first bedroom and two single beds in the second bedroom, this 54sqm beachfront accommodation offers a spacious area to enjoy. Both bathrooms are equally attractive with bath tubs. Cyprus' warm and sunny weather mostly all-year round, cherish every minute of your holidays with plenty of amenities and magnificent sea views.

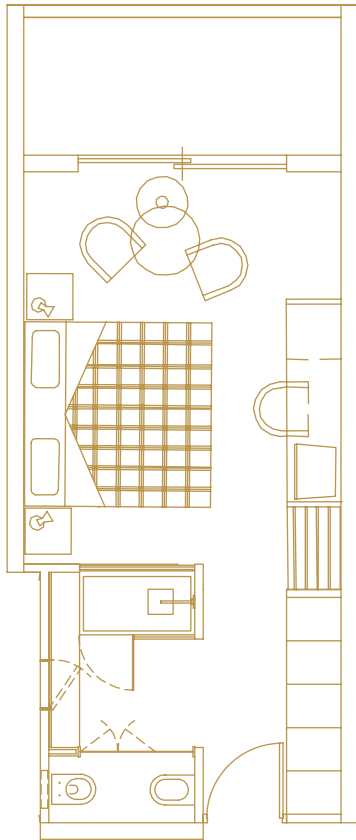

Imperial Marina

- **Total area:** 27m²
- **Available rooms:** 4
- **Bed options:** King size bed
- **Balcony area:** 5m²
- **Maximum capacity:** 2 adults

Description: The newly renovated Imperial Marina View rooms on the 6th floor are the ideal choice of your stay at the St Raphael Resort. Enjoy spectacular panoramic full frontal views of the marina and the beautiful landscaped gardens. The Imperial Marina View rooms are finished to high standards and are equipped with features ensuring a comfortable and luxury stay. Measuring to 27 square meters, they are equipped with one king size bed, as well as modern amenities including electric blinds, minibar, free Wi-Fi Internet access, satellite television, branded amenities and in-room safe.



Founder's Suite - Shukri Shammam (Honeymoon Suite)

- **Total area:** 47m²
- **Available rooms:** 1
- **Bed options:** King size bed
- **Balcony area:** 5m²
- **Maximum capacity:** 2 adults

Description: Enjoy our recently re-designed Founder's Suite, so called as this was the personal suite of the hotel owner and founder. Boasting superior design, including a bathroom with a Jacuzzi, Italian designer tiles and beautiful local marble fittings, a seating room with large plasma TV and private bar area overlooking our renovated atrium lobby from in-room windows, bedroom with a king size bed and specially designed furniture creating the ultimate Mediterranean Luxurious feel. The Suite also offers an Espresso Machine, coffee and tea making facilities, two mini bars, iPod docking station with a CD player and radio, hidden ceiling lighting, safe box and many more modern amenities. This Suite is a favourite for wedding couples and honeymooners.

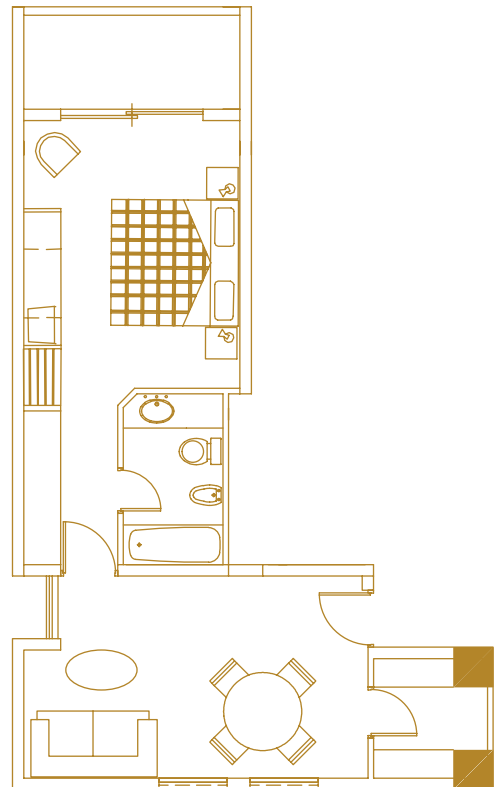

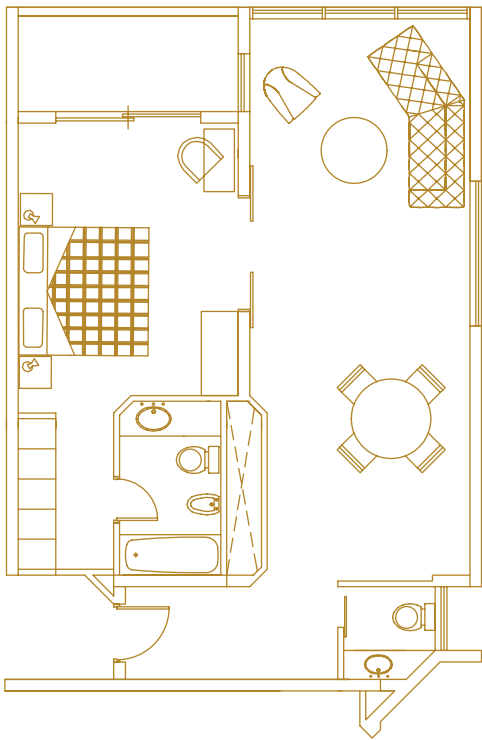

Admiral Suite

- **Total area:** 76m²
- **Available rooms:** 4
- **Bed options:** King size bed
- **Balcony area:** 5m²
- **Maximum capacity:** 3 adults or 2 adults & 2 children

Description: Host a small gathering in this spacious, 76m², sea & marina view suite. The upscale Admiral Suites located on the 4th and 5th floors of the main hotel building, offer unparalleled views of the iconic Limassol coastline and the Marina, are ideal for entertaining a small group of friends. Offering a separate bedroom, dining area and living room, you can entertain your guests in this spacious suite or call a business meeting in absolute privacy. Able to be interconnected with one Sea View Room and / or one Marina View Room, our Admiral Suites are ideal both for business as well as couples.

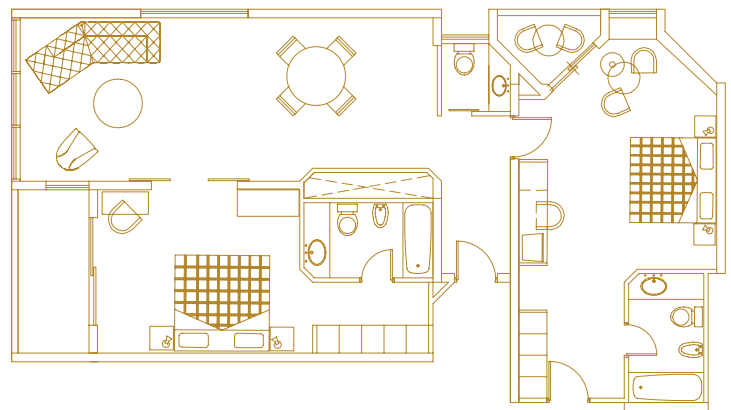

Two Bedroom Suite

- **Total area:** 105m²
- **Available rooms:** 4
- **Bed options:** King size bed & two twin single beds
- **Balcony area:** Two balconies
1 marina view 5m² & 1 sea view 2.60m²
- **Maximum capacity:** 3 adults & 3 children (minimum capacity: 2 adults & 2 children)

Description: Stay at the Two Bedroom Suite (interconnecting – Admiral Suite & Sea View Room) to give your family more space to relax. Contemporary in design, with two spacious bedrooms, separate living areas and bathrooms, make yourself at home and enjoy breathtaking views. Perfect for family or group getaways, these spacious, naturally lit suites with 103 square metres interiors, have one king size bedroom and a second bedroom with an optional king size or twin beds. Both have magnificent ensuite. Enjoy your secluded paradise with two terraces to relax and unwind. Cherish every minute of your holidays, with plenty of five-star amenities and magnificent sea and city views and spend your family beach holiday enjoying the ultimate luxury St Raphael experience.

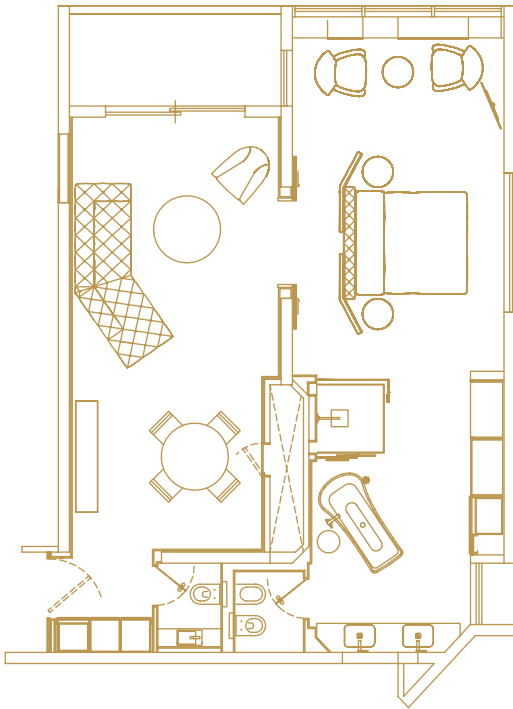

Presidential Suite

- **Total area:** 78m²
- **Available rooms:** 2
- **Bed options:** King size bed
- **Balcony area:** 5m²
- **Maximum capacity:** 2 adults & 1 child

Description: These modern and spacious suites provide every modern comfort and luxury. A king size bed (180 cm x 200 cm) looks over the side glorious views of the hotel which incorporates the mountainous backdrop against Limassol's beautiful bay. A luxurious free standing signature bathtub is incorporated into the room along with a large rain shower cubicle, separated wc, two washbasins and contemporary lighting features. The lounge has its own WC and a second TV which can be viewed from either the dining area or the comfortable designer sofa, while overlooking the blue azure of the Mediterranean.

Fully Adapted Rooms

- **Sea View room total area:** 27m²
- **Executive Inland View room total area:** 37m²
- **Available rooms:** Fully Disabled: 7 Sea View rooms / Assisted Disabled: 14 Executive Inland View rooms
- **Bed Options:** 2 single beds / double bed
- **Balcony area:** 2.6m² - 6m²
- **Maximum capacity:** 2 adults & 1 child
- **Dimensions:** Entrance door: W:84cm x H:206cm / Balcony door: W:137cm x H:218cm (Opening width only 63cm) / Bathroom door: W:90cm x H:198cm / Dimensions of bathroom: W:168cm x L:294cm

Description: Designated Sea View rooms for guests with reduced mobility and their friends and family who accompany them, which are purposefully equipped and fitted with walk in showers (room numbers 134, 204, 234, 304, 334, 604, 634).

Additionally, we offer a further 14 rooms all located in our Executive Inland View category 4th & 5th floor, in our executive wing close to our main reception level, which are also recommended for guests with reduced mobility and are classified as Assisted Disabled rooms. They have wider doors to allow ease of access of wheelchairs and offer immediate access to the hotel's facilities and main dining outlets. These rooms are also suitable for families of up to four. The public areas of the resort all present suitable access ramps and offer elevator access to every floor of the premises.

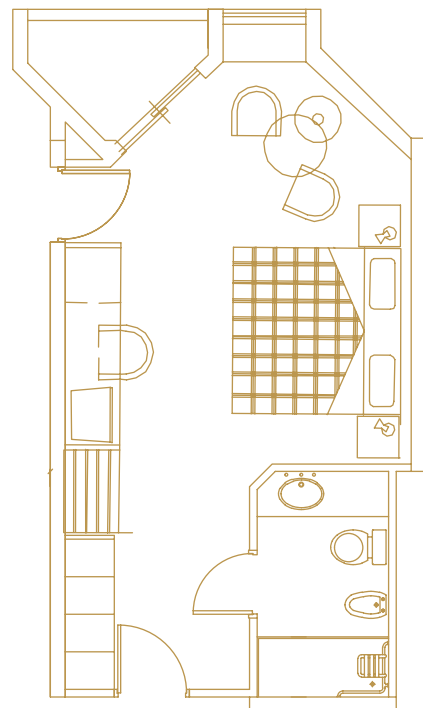



ROOM AMENITIES

- Highspeed WiFi
- Bathrobes and slippers
- Toiletries
- Hairdryer
- Direct dial telephone
- Complimentary tea & coffee making facilities
- Individually controlled central air condition/heating system
- Mini bar fridge
- 49" smart satellite T.V. with radio channels
- Safe box





ST RAPHAEL

RESORT & MARINA



LIMASSOL - CYPRUS

Bars & Restaurants



#Radiatekindness



Bars & Restaurants



From à la carte fine dining, to ethnic fusion and themed buffet culinary experiences, the St Raphael Resort & Marina offers memorable dining options for all!

The St Raphael Resort & Marina offers 8 restaurants and 2 bars. Each restaurant offers a distinctive atmosphere and themed cuisine to choose from the one that perfectly matches your palette.

RESTAURANTS

Octagon Restaurant

For an enriched bubbly buffet breakfast and a lavish buffet lunch with vegan options.

Cuisine:

International Buffet

Location:

Main building, lower floor

Opening Times:

Daily, Breakfast 07:00-10:30 /
Lunch 12:30-15:00

Dress Code:

Smart-casual (Bermuda shorts and flip flops are welcome, no beachwear)

Vegan/Vegetarian friendly

Gluten Free options

Part of All-Inclusive plan

Family/Kids friendly

Indoor/Outdoor space



*** For further details please refer to the weekly programme.**



Palladium Restaurant

Our chefs prepare and present an extensive themed rotating buffet with vegan options to ensure that you enjoy something different every night.

Cuisine

Themed Buffet

Location

Main building, lower floor

Opening Times

Daily, dinner from 19:00 - 22:00

Dress Code

Smart-casual (Bermuda shorts are welcome, no beachwear or flip-flops)

Vegan/Vegetarian friendly

Gluten Free options

Part of All-Inclusive plan

Family/Kids friendly/Indoor

Alakati Cyprus Taverna

Dine under the stars, while our chefs are grilling live on the spot next to you and serving traditional and fusion Cyprus specialities, including meat and fish plates.

Cuisine

Cypriot Meze

Location

Outdoor - Gardens

Opening Times

Mid-May - October (weather permitting)
19:30hrs - 22:00hrs

Dress Code

Smart-casual

Vegan/Vegetarian friendly

Gluten Free options

Part of All-Inclusive plan

Family/Kids friendly

Outdoor space



*** For further details please refer to the weekly programme.**



Splash Street Food Restaurant

This outdoor restaurant is located next to the Executive Wing's pool and is serving concept street food. You can enjoy a selection a freshly made salads to souvlaki, burgers and many more.

Cuisine

Modern Street Food

Location

Outdoor by the Splash Pool

Opening Times

10:00hrs - 18:00hrs

Open Daily

Dress Code

T-shirts and open shoes are permitted.

Tops must always be worn. Guests are kindly requested to avoid entering wet or barefoot for safety reasons.

Vegan/Vegetarian options

Gluten Free options

Family/Kids friendly

Part of All-Inclusive plan

Seashells Healthy Living Vegan Restaurant

This is the only 100% Vegan restaurant on the island which is located right on the beach and is serving Vegan food. Healthy living and healthy appetite are what you need.

Cuisine

Vegan

Location

By the St Raphael beach

Opening Times

Mid-May - October (weather permitting)

Daily from 10:00-19:00 / Lunch 12:30-15:00

Last order 18:30hrs

Dress Code

T-shirts and open shoes are permitted.

Tops must always be worn. Guests are kindly requested to avoid entering wet or barefoot for safety reasons.

Vegan/Gluten Free options

Family/Kids friendly

Take-away available

Outdoor space

Part of All-Inclusive Terms



*** For further details please refer to the weekly programme.**



Golden Monkey Authentic Thai Restaurant

The Restaurant is located on the ground floor of the Tower. This exclusive Thai Restaurant specialises in authentic and modern Thai cuisine.

Cuisine

Authentic Thai

Location

Level B at The Tower

Opening Times

Daily from 19:00 - 00:30
(last food order 22:30)
Closed every Tuesday

Dress Code

Smart-casual (no shorts, beachwear or flip-flops)

Reservations are strongly recommended

Vegan/Vegetarian options

Gluten Free options

Ristorante Dolce Vita

Dine al fresco and enjoy an Italian sharing menu. An ideal spot for an unforgettable culinary experience under the stars.

Cuisine

Italian Sharing Menu

Location

Outdoor Amphitheater, next to the Chapel

Opening Times

Mid May - October (weather permitting)
Open twice a week, 19:30 - 22:00

Dress Code Smart-casual



*** For further details please refer to the weekly programme.**



BARS



Captain's Bar & Terrace

Our popular Captain's Bar has its own wooden decked terrace overlooking the hotel's beautifully kept landscaped gardens, where our guests can enjoy our signature cocktails and absorb the breath-taking views of the Mediterranean Sea and St Raphael Marina.

Cuisine

Light snacks, drinks and cocktails

Location

Main Building - Ground floor and terrace

Opening Times

Daily from 09:00 - 01:00

Dress Code: Smart-casual

Indoor/Outdoor space

Family/Kids friendly

Part of All-Inclusive plan

Amphibion Pool Bar (Swim Up)

An icon synonymous with summer memories at St Raphael, swim up to the bar and order from a wide variety of drinks and cocktails while enjoying the warm Mediterranean sun. Enjoy a fresh, creative cocktail while lounging poolside.

Cuisine

Drinks and cocktails

Location

Outdoor

Opening Times

Daily from 10:00 - 18:00

Dress Code: T-shirts and open shoes are permitted. Tops must always be worn. Guests entering from the pool are kindly requested to avoid entering wet or barefoot for safety reasons

Family/Kids friendly

Part of All-Inclusive plan

Outdoor space



*** For further details please refer to the weekly programme.**



ST RAPHAEL

RESORT & MARINA

★ ★ ★ ★ ★

LIMASSOL - CYPRUS

Entertainment

Sports, Animation &
Recreational Facilities



#Radiatekindness



Entertainment

Sports, Animation & Recreational Facilities

SCAN ME



ENTERTAINMENT
& ANIMATION

- 2 outdoor, fresh-water swimming pools, one with swim up bar and one with water slide
- 2 outdoor children's pools (one shaded)
- Complimentary towels, sun beds and umbrellas by the pool, gardens & beach
- Water sports (at extra charge)
- Diving centre
- Fully equipped eco gym room, jacuzzi, sauna, steam bath and an indoor heated swimming pool (November - March)
- Spa facilities and hairdresser at our Serenity Spa
- Childrens outdoor playground
- Kids facilities
- Babysitting services available upon request (charges per hour)
- Eden Garden's with electronic games
- Day animation (refer to weekly program) (May - October)
- Evening entertainment includes various musical and dancing live shows
- 2 tennis courts with artificial grass (extra charge for floodlights only). Tennis rackets and balls are loaned free of charge
- Kids animation and kids mini club

Other sports and facilities nearby (at extra charge):

- Golf courses
- Horse riding
- Mini golf
- Go-karts
- Wall climbing
- Golf driving range
- Shooting
- Aviation simulator
- Zoo & animal parks
- Waterpark



* For further details please refer to the weekly programme.





ST RAPHAEL

RESORT & MARINA



LIMASSOL - CYPRUS

Serenity
Spa



#Radiatekindness



Serenity Spa



Serenity Spa at St Raphael Resort and Marina believes firmly in sustainability. We want to support our local heritage, culture, nature, traditions and people. Our staff are carefully selected and trained to the highest standards, in doing so we do not only offer the best customer service, but also create the best team spirit and the best balance of expertise.

We want to offer all our customers, hotel guests, members and locals alike with the best of Cyprus: friendly service, Impeccable treatments and local products with pure nature being at the heart of our philosophy. Not only are none of the products, we choose to work with, tested on animals, but where possible they have been certified vegan and are from

organic and natural sources. Furthermore, all products we work with are from companies that firmly stand for the environment, their local people and neighbors, and promoting natural, pure ingredients.

We have no doubt that you, our valued and most special guests, will enjoy every part of your experience at our award winning spa. We look forward to welcoming you as part of the 'Serenity Spa' family and will be delighted to help you in any part of your spa journey from selecting a treatment, tailor-making a package just for you and in advising on "after spa" programmes.

Spa Treatments

We firmly believe that the best place to treat your body, spirit and mind is in the spa. Our highly trained, experienced therapists and beauty specialists will take their time to suggest the best treatment and products based on the nature of your skin, your personal sensitivities and beauty objectives.

- Massage Therapies
- Body Treatments
- Face Care
- Make-up
- Beauty for hands and feet
- Serenity Hair Salon





ST RAPHAEL

RESORT & MARINA



LIMASSOL - CYPRUS

All Inclusive Package



#Radiatekindness



All Inclusive Package

Rest and relaxation are at your fingertips at the St Raphael Resort & Marina. The Resort is situated right on a blue flag accredited beach, and is offering among other accommodation packages an all-inclusive option. The St Raphael Resort & Marina is rightfully regarded as one of the best 5-star luxury resorts in Cyprus, and by taking advantage of our **all-inclusive package**, you can have a stress-free getaway.

Guests are welcome to begin their morning with a sumptuous buffet breakfast and a glass of fresh orange juice or even a glass full of bubbles, and then let the day unfold while taking part in a great range of leisure and sports activities, experiencing delicious meals or light snacks and refreshments by the beach, or you can just relax by the pool and enjoy the endless horizon and the blue waters of the Mediterranean Sea.

St Raphael Resort and Marina is the ideal place for families, where children and adults alike have their own spaces to enjoy, but at the same time the opportunity to participate in various activities so to spend quality time together as a family.

Added value services and facilities:

- Welcome drink upon check in
- Still water in room (daily)
- Fresh fruit in room upon arrival
- Water and soft drinks in mini fridge on arrival (replenished weekly)
- Non-motorised water activities (canoe and pedal boats / Summer)





Meal Options

Breakfast:

Octagon Restaurant

Vegan/Vegetarian friendly, Gluten free options, Indoor/Outdoor seating

Cuisine: International Buffet | **Location:** Main building, lower level

Opening Times: Daily, Breakfast 07:00-10:30

Dress Code: Smart-casual (Bermuda shorts and flip flops are welcome, no beachwear)

Lunch:

Octagon Restaurant

Vegan/Vegetarian friendly, Gluten free options, Indoor/Outdoor seating

Cuisine: International Buffet | **Location:** Main building, lower level | **Opening Times:** 12:30-15:00

Dress Code: Smart-casual (Bermuda shorts and flip flops are welcome, no beachwear)

Splash Restaurant & Bar

Vegan/Vegetarian friendly, Gluten free options

Cuisine: Street Food menu | **Location:** Outdoor by the Splash Pool | **Opening Times:** May - October (weather permitting)
Daily from 10:00 - 18:00 / Drinks 10:00 - 18:00 / Cold Snacks: 10:30 - 12:00 & 15:30 - 18:00 / A la carte Menu: 12:30 - 15:00

Dress Code: T-shirts and open shoes are permitted. Tops must always be worn. Guests using the pool are kindly requested to avoid entering wet or barefoot for safety reasons.

Seashells Healthy Living

Vegan, Gluten free options, Take-away available

Part of the All-Inclusive Terms

Cuisine: Vegan | **Location:** By the beach | **Opening Times:** May - October (weather permitting) Daily 10:00 - 19:00
Drinks: 10:00 - 19:00 / A La Carte Menu: 12:30 - 15:00

Dress Code: T-shirts and open shoes are permitted. Tops must always be worn. Guests using the beach are kindly requested to avoid entering wet or barefoot for safety reasons.

Dinner:

Palladium Restaurant

Vegan/Vegetarian friendly, Gluten free options

Cuisine: Themed Buffet | **Location:** Main Building, lower level | **Opening Times:** Daily from 19:00 - 22:00

Dress Code: Smart-casual (Bermuda shorts are welcome, no beachwear, sandals or flip-flops)

Alakati Restaurant

Vegan/Vegetarian friendly, Gluten free options

Cuisine: Cypriot Meze | **Location:** Outdoor | **Opening Times:** May to October (weather permitting)

Opens according to Restaurant's weekly program from 7:30pm until 10:00pm

Dress Code: Smart-casual

Ristorante Dolce Vita

Vegan/Vegetarian friendly, Gluten free options

Cuisine: Italian Sharing Menu | **Location:** Outdoor | **Opening Times:** Mid May - October (weather permitting)

Opens according to Restaurant's weekly program from 7:30pm until 10:00pm

Dress Code: Smart-casual



Snacks:

Splash Restaurant & Bar

Vegan/Vegetarian friendly, Gluten free options

Cuisine: Cold Snacks | **Location:** Outdoor by the Splash Pool

Opening Times: May - October (weather permitting) 10:30 - 12:00 and 15:30 - 18:00

Dress Code: T-shirts and open shoes are permitted. Tops must always be worn. Guests using the pool are kindly requested to avoid entering wet or barefoot for safety reasons.

Octagon Restaurant

Vegan/Vegetarian friendly, Gluten free options, Indoor/Outdoor seating

Cuisine: Cold Snacks | **Location:** Main building, lower level

Opening Times: 10:30 - 12:00 and 15:30 - 18:00 / Nov - Apr

Dress Code: Smart-casual (Bermuda shorts and flip flops are welcome, no beachwear)

Bar Options

Captain's Bar and Terrace

Menu: Beverages and Cocktails | **Location:** Main Building - Ground level and terrace

Opening Times: Daily from 09:00 - 01:00

Dress Code: Smart-casual (Bermuda shorts and flip flops are welcome, no beachwear)

- Unlimited consumption of only selected local and international beverages, spirits and cocktails
- All Inclusive service is available from 10:00 until midnight

Amphibion Pool Bar

Menu: Beverages and Cocktails | **Location:** Outdoor - Swim-up Bar at Amphibion Pool

Opening Times: Daily 10:00 - 18:00 May - October (weather permitting)

Dress Code: Casual

- Unlimited consumption of only selected local and international beverages, spirits and cocktails



- * The management reserves the right to amend any of the above without prior notice
- * On departure day the all inclusive services can be enjoyed until 15:00hrs



ST RAPHAEL

RESORT & MARINA

★ ★ ★ ★ ★

LIMASSOL - CYPRUS

Events & Conferences



#Radiatekindness



Events & Conferences

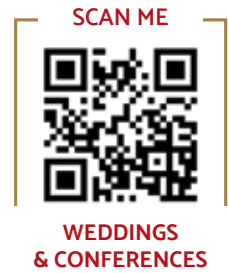

Discover elegance and flexibility at the St Raphael Resort & Marina. Offering an array of impressive indoor and outdoor venues for you to choose from, as well as ample on-site parking for all your attendees, our meeting facilities and banquet halls can be arranged and equipped to fulfil all your needs. Be it a board meeting, training session, banquet or lecture, the combination of space, facilities and service provided by our team of experts, place the St Raphael Resort & Marina the leading conference Resort in Cyprus.



Panorama Hall

Maximum Capacity: 525

The octagonal shape "Panorama" Conference Hall is a recently refurbished pillar-free room, offering spectacular 180-degree sea views and boasting 529m² of unobstructed meeting space. Designed to accommodate larger events, from regional business meetings to fashion shows, it can accommodate anything from 250 to 300 people for sit down dinner and over 700 people for a cocktail reception.

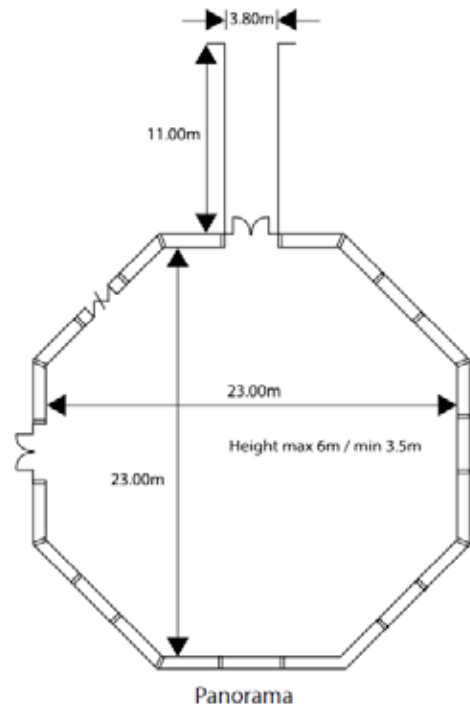



Megarons A, B and C

For meetings from 50 up to 150 delegates Megarons (A, B, C) are the ideal venues. These well-suited spacious meeting rooms offer flexible layouts and can be adapted to suit every situation and meet your requirements. Offering the the perfect space for hosting seminars, trainings, exhibitions, networking and small conferences. All meeting rooms at the St Raphael Resort & Marina have been approved and licensed by the Human Resource Development Authority (HRDA) and are certified as ideal venues for organizing company trainings.

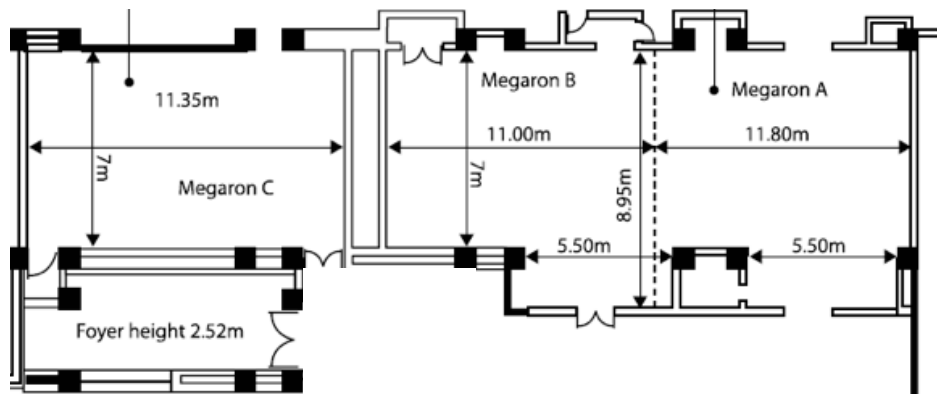

Phoenix

Situated on the first floor of our Executive Wing, it can accommodate up to 200 persons theater style, Phoenix conference room is a multipurpose room measuring 267m², giving organisers additional accessible, flexible and versatile options when planning their events. This space is ideal not only for meetings but also for product launches, trade shows, receptions and of course, exhibitions.

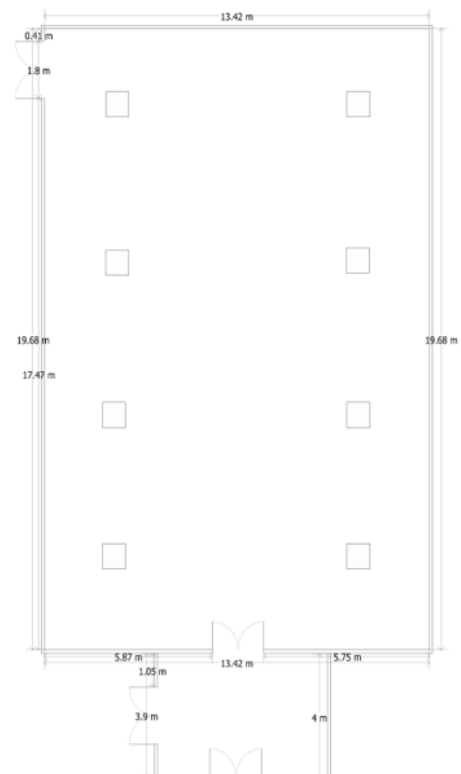



Atriums A, B and C

For gatherings from 50 up to 80 delegates we offer air-conditioned meetings space at our Atrium rooms (A, B & C). These well-suited spacious rooms located in our Executive Wing, offer flexible layouts and can be adapted to suit every situation and meet your requirements. We offer the perfect space for hosting seminars, trainings, networking and small conferences. All meeting rooms at the St Raphael Resort have been approved and licensed by the Human Resource Development Authority (HRDA).

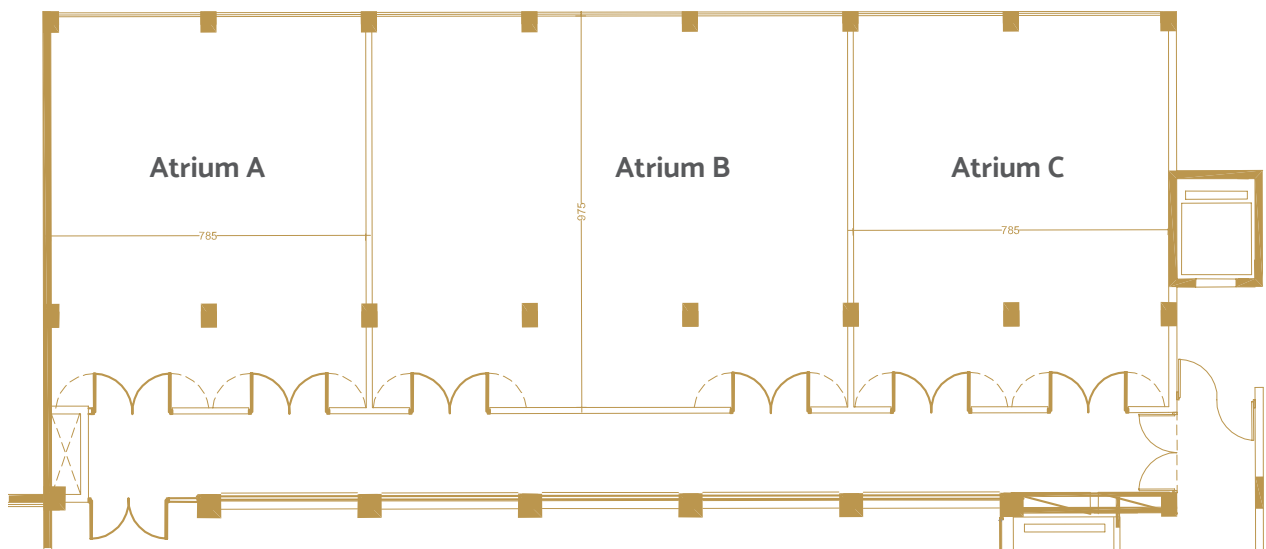

MEETING ROOM EQUIPMENT







At the St Raphael Resort we offer modern Audio / Visual Equipment along with professional technical and support services to ensure your next meeting or event is an outstanding success. Whether you're giving a major presentation or simply organizing "that thing you were assigned to do," our talented events team is eager to assist you in realizing your vision and setting up the room perfectly for max-

imum effect. Our meeting rooms are fitted with all the necessary elements to carry out successful meetings, events and presentations such as: Free Wi-Fi, air conditioning and heating, Audio-visual Equipment along with flipcharts and markers. If we do not have what you are looking for, we'll happily track it down and have it here for you with just a little advance notice.



Conference Facilities

“Voted Cyprus Leading Conference Resort”

Halls	m ²	Ceiling Height	Seating Capacity	Theatre	Classroom	U Shape	Cabaret	Banquet	Cocktail
									
Panorama	529	3,4-5	-	500	300	60	160	320	700
Panorama Corridor	37.8	2,4	-	-	-	-	-	-	-
Phoenix	267	3,20	-	200	100	60	80	100	300
Megaron Alpha	82.6	3,4	-	80	50	30	32	-	100
Megaron Beta	82.6	3,4	-	80	50	30	32	-	100
Megaron Gamma	79	3,6	-	70	40	26	32	-	100
Megaron A & B	165	3,4	-	200	100	60	6	-	200
Megaron Foyer A & B	51.5	3,4-8	-	-	-	-	-	-	-
Megaron Foyer C	18.5	2,5	-	-	-	-	-	-	-
Atrium A	73	3	-	40	30	20	-	-	-
Atrium B	111	3	-	80	60	27	40	-	-
Atrium C	73	3	-	40	30	20	-	-	-

Other Conference Facilities

Halls	m ²	Boardroom
Gallery A	17	8
Gallery B	18	10
Gallery C	19	10



ST RAPHAEL

RESORT & MARINA

★ ★ ★ ★ ★

LIMASSOL - CYPRUS

Children

Facilities & Animation



#Radiatekindness



Children

Facilities & Animation

St Raphael Resort is a perfect choice for a luxury family all inclusive holiday to Limassol, Cyprus. The Resort has two areas where kids can spend an enjoyable time, our Happy Bee supervised kids club opening May to October and the Toucan Kids Club, opening November till April, where parents can rest in the knowledge that their children are having fun

in a safe and secure environment. Our professional team of entertainers offer a range of educational and fun activities for children between the ages of 4 - 12 years old. Baby-sitting services are available at a fee from our reception, advanced bookings are required.

Happy Bee Kids Club

Our Happy Bee supervised kids club provides a range of activities for children between the ages 4 - 12, 7 days per week.

May - October

There are a range of activities organised each day at these time periods:

- 10:00hrs - 12:30hrs
- 14:30hrs - 16:30hrs

* Opening hours are subject to change



Toucan Kids Club

Our Toucan kids club provides a range of activities for children between the ages 4 - 12, 7 days per week.

November - April

There are a range of activities organised each day at these time periods:

- 10:00hrs - 12:30hrs
- 14:30hrs - 16:30hrs

* Opening hours are subject to change

Eden Garden Games Rooms

Eden Garden Games Rooms has now been completed and is fully functional with many of our younger, independent guests frequenting this room daily. This cozy, safe atmosphere with entertainment to suit youngsters, a huge selection of arcade games, table tennis table, pool table, table hockey and other amusing games.



*** For further details and kids activities, please refer to the weekly programme.**